

CSF16 and CSF16T
Stainless Steel Steam and Sterile Air Filters
Installation and Maintenance Instructions

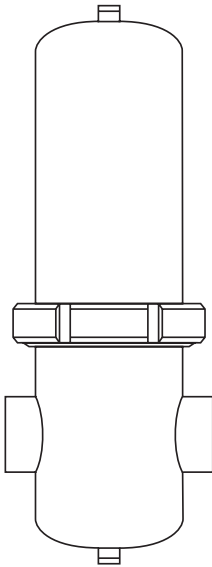

DN8 to DN80

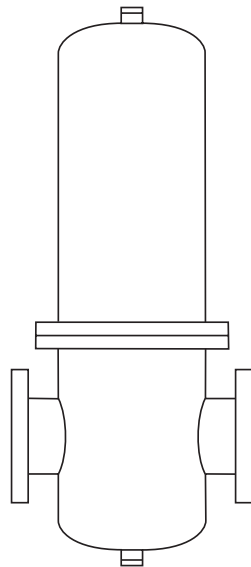

DN100 and DN150

Contents

1	Safety information	4
2	General product information	7
2.1	Description	
2.2	Sizes and pipe connections	15
2.3	Pressure/temperature limits for steam applications	17
2.4	Pressure/temperature limits for sterile air applications	29
3	Installation	
3.1	Supply	41
3.2	Installation	
4	Commissioning	44
5	Operation	
5.1	Steam filters	48
5.2	Sterile air filters	
6	Maintenance	
6.1	General information	49
6.2	Filter element maintenance	
7	Spare parts	
7.1	Available spares	50
7.2	CSF16 seal kit cross reference table	
7.3	Seal kit contents	
7.4	How to order spares	51
7.5	Stainless steel steam filters spares	52
7.6	Stainless steel sterile air filters	53

1. Safety information

Safe operation of these products can only be guaranteed if they are properly installed, commissioned, used and maintained by qualified personnel (see Section 1.11) in compliance with the operating instructions. General installation and safety instructions for pipeline and plant construction, as well as the proper use of tools and safety equipment must also be complied with.

This product is intended to be connected into a system that can operate an EC 1935 compliant process.

To minimise the risk of non-intentionally added substances in the system, it is essential that an appropriate CIP (cleaning-in-place) cycle is carried out by the end user prior to first use in a food contact application.

A list of all the materials that could come directly into contact with foodstuffs can be found in the Declaration of Conformity supplied with this product.

1.1 Intended use

Referring to the Installation and Maintenance Instructions, name-plate and Technical Information Sheet, check that the product is suitable for the intended use/application. These products comply with the requirements of the EU Pressure Equipment Directive/UK Pressure Equipment (Safety) Regulations and carry the  mark when so required.

Refer to filter housing selection matrix in section 2.1 for details of PED categories.

- i) The filter housings have been specifically designed for use on steam, air, inert industrial gases and liquids which are in Group 2 of the Pressure Equipment Directive. The complete filter assembly including element(s) has been validated for use on steam and compressed air systems. The products' use on other fluids may be possible but, if this is contemplated, Spirax Sarco should be contacted to confirm the suitability of the product for the application being considered.
- ii) Check material suitability, pressure and temperature and their maximum and minimum values. If the maximum operating limits of the product are lower than those of the system in which it is being fitted, or if malfunction of the product could result in a dangerous overpressure or over temperature occurrence, ensure a safety device is included in the system to prevent such over-limit situations. Determine the correct installation situation and direction of fluid flow.
- iii) Spirax Sarco products are not intended to withstand external stresses that may be induced by any system to which they are fitted. It is the responsibility of the installer to consider these stresses and take adequate precautions to minimise them. Reaction forces must be considered and are the responsibility of the person installing this product.
- iv) Remove all packaging and protective covers from the product where applicable before installation.

1.2 Access

Ensure safe access and if necessary a safe working platform (suitably guarded) before attempting to work on the product. Arrange suitable lifting gear if required.

1.3 Lighting

Ensure adequate lighting, particularly where detailed or intricate work is required.

1.4 Hazardous liquids or gases in the pipeline

Consider if there is any risk of residual fluids in the pipeline before starting work. Consider if there are any flammable materials, substances hazardous to health, extremes of temperature.

1.5 Hazardous environment around the product

Consider: explosion risk areas, lack of oxygen (e.g. tanks, pits), dangerous gases, extremes of temperature, hot surfaces, fire hazard (e.g. during welding), excessive noise, moving machinery.

1.6 The system

Consider the effect on the complete system of the work proposed. Will any proposed action (e.g. closing isolation valves, electrical isolation) put any other part of the system or any personnel at risk? Dangers might include isolation of vents or protective devices or the rendering ineffective of controls or alarms. Ensure isolation valves are turned on and off in a gradual way to avoid system shocks.

1.7 Pressure systems

Ensure that any pressure is isolated and safely vented to atmospheric pressure. Do not assume that the system has depressurised even when the pressure gauge indicates zero.

1.8 Temperature

Allow time for temperature to normalise after isolation to avoid danger of burns.

1.9 Tools and consumables

Before starting work ensure that you have suitable tools and/or consumables available. Use only genuine Spirax Sarco replacement parts.

1.10 Protective clothing

Consider whether you and/or others in the vicinity require any protective clothing to protect against the hazards of, for example, chemicals, high/low temperature, radiation, noise, falling objects, and dangers to eyes and face.

1.11 Permits to work

All work must be carried out or be supervised by a suitably competent person. Installation and operating personnel should be trained in the correct use of the product according to the Installation and Maintenance Instructions.

Where a formal 'permit to work' system is in force it must be complied with. Where there is no such system, it is recommended that a responsible person should know what work is going on and, where necessary, arrange to have an assistant whose primary responsibility is safety. Post 'warning notices' if necessary.

1.12 Handling

Manual handling of large and/or heavy products may present a risk of injury. Lifting, pushing, pulling, carrying or supporting a load by bodily force can cause injury particularly to the back. You are advised to assess the risks taking into account the task, the individual, the load and the working environment and use the appropriate handling method depending on the circumstances of the work being done.

1.13 Residual hazards

In normal use the external surface of the product may be very hot. If used at the maximum permitted operating conditions the surface temperature may reach temperatures in excess of 220 °C (428 °F). Many products are not self-draining. Take due care when dismantling or removing the product from an installation (refer to 'Maintenance instructions').

1.14 Freezing

Provision must be made to protect products which are not self-draining against frost damage in environments where they may be exposed to temperatures below freezing point.

1.15 Disposal

The product is recyclable. No ecological hazard is anticipated with the disposal of this product providing due care is taken.

1.16 Returning products

Customers and stockists are reminded that under EC Health, Safety and Environment Law, when returning products to Spirax Sarco they must provide information on any hazards and the precautions to be taken due to contamination residues or mechanical damage which may present a health, safety or environmental risk. This information must be provided in writing including Health and Safety data sheets relating to any substances identified as hazardous or potentially hazardous.

2. General product information

2.1 Description

The CSF16 and CSF16T are horizontal, in-line high efficiency filters used to remove particulate contamination from steam and sterile air systems.

Filter Housings options matrix

CSF16 Filter Housing Options, PED Classification and Design Reference (PT Curve)

Filter Housing Size	Filter Housing code	Filter Housing Seal Material	Screwed Filter Housings (Design reference/PED Category)		Flanged Filter Housings (Design reference/PED Category)			
			BSP/NPT (PN10 Rating)	BSP/NPT (PN16 Rating)	EN 1092 (PN10 Rating)	EN 1092 (PN16 Rating)	EN 1735-1 (Class 150 Rating)	
DN8 (1/4")	CSF 16	EPM		Design Ref. 1/SEP				
DN10 (3/8")	CSF 16			Design Ref. 1/SEP		Design Ref. 1/SEP		
DN15 (1/2")	CSF 16			Design Ref. 1/SEP		Design Ref. 1/SEP	Design Ref. 3/SEP	
DN20 (3/4")	CSF 16			Design Ref. 1/SEP		Design Ref. 1/SEP	Design Ref. 3/SEP	
DN25 (1")	CSF 16			Design Ref. 1/SEP		Design Ref. 1/SEP	Design Ref. 3/SEP	
DN32 (1 1/4")	CSF 16			Design Ref. 1/SEP		Design Ref. 1/SEP	Design Ref. 3/SEP	
DN40 (1 1/2")	CSF 16				Design Ref. 1/SEP		Design Ref. 3/Cat. I	
DN50 (2")	CSF16L				Design Ref. 1/Cat. I		Design Ref. 1/Cat. I	Design Ref. 3/Cat. I
	CSF16H				Design Ref. 1/Cat. I		Design Ref. 1/Cat. I	Design Ref. 3/Cat. I
DN65 (2 1/2")	CSF16				Design Ref. 1/Cat. I		Design Ref. 1/Cat. I	Design Ref. 3/Cat. I
DN80 (3")	CSF16L				Design Ref. 1/Cat. II		Design Ref. 1/Cat. II	Design Ref. 3/Cat. II
	CSF16H			Design Ref. 2/Cat. I		Design Ref. 2/Cat. I		Design Ref. 3/Cat. II

Not available

The PED categories indicated in the table above are for Group 2 gases. For Group 2 liquids, all product are designated SEP.

CSF16 Filter Housing Options, PED Classification and Design Reference (PT Curve) - continued

Filter Housing Size	Filter Housing code	Filter Housing Seal Material	Screwed Filter Housings (Design reference/PED Category)		Flanged Filter Housings (Design reference/PED Category)		
			BSP/NPT (PN10 Rating)	BSP/NPT (PN16 Rating)	EN 1092 (PN10 Rating)	EN 1092 (PN16 Rating)	EN 1735-1 (Class 150 Rating)
DN8 (¼")	CSF16	Fluoraz		Design Ref. 4/SEP			
DN10 (⅜")	CSF16			Design Ref. 4/SEP		Design Ref. 4/SEP	
DN15 (½")	CSF16			Design Ref. 4/SEP		Design Ref. 4/SEP	Design Ref. 5/SEP
DN20 (¾")	CSF16			Design Ref. 4/SEP		Design Ref. 4/SEP	Design Ref. 5/SEP
DN25 (1")	CSF16			Design Ref. 4/SEP		Design Ref. 4/SEP	Design Ref. 5/SEP
DN32 (1¼")	CSF16			Design Ref. 4/SEP		Design Ref. 4/SEP	Design Ref. 5/SEP
DN40 (1½")	CSF16			Design Ref. 4/SEP		Design Ref. 4/SEP	Design Ref. 5/Cat. I
DN50 (2")	CSF16L			Design Ref. 4/Cat. I		Design Ref. 4/Cat. I	Design Ref. 5/Cat. I
	CSF16H			Design Ref. 4/Cat. I		Design Ref. 4/Cat. I	Design Ref. 5/Cat. I
DN65 (2½")	CSF16			Design Ref. 4/Cat. I		Design Ref. 4/Cat. I	Design Ref. 5/Cat. I
DN80 (3")	CSF16L			Design Ref. 4/Cat. II		Design Ref. 4/Cat. II	Design Ref. 5/Cat. II
	CSF16H			Design Ref. 6/Cat. I	Design Ref. 4/Cat. II	Design Ref. 6/Cat. I	Design Ref. 4/Cat. II
DN100 (4")	CSF16L	Stainless steel Steel/ PTFE			Design Ref. 6/Cat. II	Design Ref. 4/Cat. II	Design Ref. 5/Cat. II
	CSF16H				Design Ref. 6/Cat. II	Design Ref. 4/Cat. II	Design Ref. 5/Cat. II
DN150 (6")	CSF16L	Spiral Wound Gasket			Design Ref. 6/Cat. II		
	CSF16H						

Not available

The PED categories indicated in the table above are for Group 2 gases. For Group 2 liquids, all product are designated SEP.

CSF16T Filter Housing Options, PED Classification and Design Reference (PT Curve)

Filter Housing Size	Filter Housing code	Filter Housing Seal Material	Screwed Filter Housings (Design reference/PED Category)		Flanged Filter Housings (Design reference/PED Category)		
			BSP/NPT (PN10 Rating)	BSP/NPT (PN16 Rating)	EN 1092 (PN10 Rating)	EN 1092 (PN16 Rating)	EN 1735-1 (Class 150 Rating)
DN8 (¼")	CSF16T	EPM		Design Ref. 7/SEP			
DN10 (⅜")	CSF16T			Design Ref. 7/SEP		Design Ref. 7/SEP	
DN15 (½")	CSF16T			Design Ref. 7/SEP		Design Ref. 7/SEP	Design Ref. 9/SEP
DN20 (¾")	CSF16T			Design Ref. 7/SEP		Design Ref. 7/SEP	Design Ref. 9/SEP
DN25 (1")	CSF16T			Design Ref. 7/SEP		Design Ref. 7/SEP	Design Ref. 9/SEP
DN32 (1¼")	CSF16T			Design Ref. 7/SEP		Design Ref. 7/SEP	Design Ref. 9/SEP
DN40 (1½")	CSF16T			Design Ref. 7/SEP		Design Ref. 7/SEP	Design Ref. 9/Cat. I
DN50 (2")	CSF16LT			Design Ref. 7/Cat. I		Design Ref. 7/Cat. I	Design Ref. 9/Cat. I
	CSF16HT			Design Ref. 7/Cat. I		Design Ref. 7/Cat. I	Design Ref. 9/Cat. I
DN65 (2½")	CSF16T			Design Ref. 7/Cat. I		Design Ref. 7/Cat. I	Design Ref. 9/Cat. I
DN80 (3")	CSF16LT			Design Ref. 7/Cat. II		Design Ref. 7/Cat. II	Design Ref. 9/Cat. II
	CSF16HT			Design Ref. 8/Cat. I		Design Ref. 8/Cat. I	Design Ref. 9/Cat. II

Not available

The PED categories indicated in the table above are for Group 2 gases. For Group 2 liquids, all product are designated SEP.

CSF16T Filter Housing Options, PED Classification and Design Reference (PT Curve) - continued

Filter Housing Size	Filter Housing code	Filter Housing Seal Material	Screwed Filter Housings (Design reference/PED Category)		Flanged Filter Housings (Design reference/PED Category)			
			BSP/NPT (PN10 Rating)	BSP/NPT (PN16 Rating)	EN 1092 (PN10 Rating)	EN 1092 (PN16 Rating)	EN 1735-1 (Class 150 Rating)	
DN8 (¼")	CSF16T	Fluoraz		Design Ref. 10/SEP				
DN10 (⅜")	CSF16T			Design Ref. 10/SEP		Design Ref. 10/SEP		
DN15 (½")	CSF16T			Design Ref. 10/SEP		Design Ref. 10/SEP	Design Ref. 11/SEP	
DN20 (¾")	CSF16T			Design Ref. 10/SEP		Design Ref. 10/SEP	Design Ref. 11/SEP	
DN25 (1")	CSF16T			Design Ref. 10/SEP		Design Ref. 10/SEP	Design Ref. 11/SEP	
DN32 (1¼")	CSF16T			Design Ref. 10/SEP		Design Ref. 10/SEP	Design Ref. 11/SEP	
DN40 (1½")	CSF16T			Design Ref. 10/SEP		Design Ref. 10/SEP	Design Ref. 11/Cat. I	
DN50 (2")	CSF16LT			Design Ref. 10/Cat. I		Design Ref. 10/Cat. I	Design Ref. 11/Cat. I	
	CSF16HT			Design Ref. 10/Cat. I		Design Ref. 10/Cat. I	Design Ref. 11/Cat. I	
DN65 (2½")	CSF16T			Design Ref. 10/Cat. I		Design Ref. 10/Cat. I	Design Ref. 11/Cat. I	
DN80 (3")	CSF16LT			Design Ref. 10/Cat. II		Design Ref. 10/Cat. II	Design Ref. 11/Cat. II	
	CSF16HT			Design Ref. 12/Cat. I	Design Ref. 10/Cat. II	Design Ref. 12/Cat. I	Design Ref. 10/Cat. II	Design Ref. 11/Cat. II
DN100 (4")	CSF16LT		Stainless steel Steel/ PTFE Spiral Wound Gasket			Design Ref. 12/Cat. II	Design Ref. 10/Cat. II	Design Ref. 11/Cat. II
	CSF16HT					Design Ref. 12/Cat. II	Design Ref. 10/Cat. II	Design Ref. 11/Cat. II
DN150 (6")	CSF16LT				Design Ref. 12/Cat. II			
	CSF16HT							

Not available

The PED categories indicated in the table above are for Group 2 gases. For Group 2 liquids, all product are designated SEP.

For further technical information on product housing, seal materials and filter element types see separate technical information sheets TI-P180-43 (steam) and TI-P180-44 (sterile air).
 It is important that the appropriate filter element(s) are selected for a given application and model of filter housing.

See tables below to confirm that you have the correct filter element and seal before installation.

CSF16 and CSF16T filter housing options and corresponding filter elements

Filter housing			Steam filter element				
Filter housing size	Filter housing code	Filter housing seal material	1µm/5µm/25µm O-ring seal type	Filter element code	No. of elements per housing		
DN8 (¼")	CSF16/CSF16T	EPM	EPM	CSF16-SE 03/10	1		
DN10 (⅜")	CSF16/CSF16T			CSF16-SE 04/10	1		
DN15 (½")	CSF16/CSF16T			CSF16-SE 04/20	1		
DN20 (¾")	CSF16/CSF16T			CSF16-SE 05/20	1		
DN25 (1")	CSF16/CSF16T			CSF16-SE 05/25	1		
DN32 (1¼")	CSF16/CSF16T			CSF16-SE 07/25	1		
DN40 (1½")	CSF16/CSF16T			CSF16-SE 07/30	1		
DN50 (2")	CSF16L/CSF16LT			CSF16-SE 10/30	1		
	CSF16H/CSF16HT			CSF16-SE 15/30	1		
DN65 (2½")	CSF16/CSF16T			CSF16-SE 20/30	1		
DN80 (3")	CSF16L/CSF16LT			CSF16-SE 30/30	1		
	CSF16H/CSF16HT			CSF16-SE 30/50	1		
DN8 (¼")	CSF16/CSF16T			Fluoraz	Fluoraz	CSF16-SF 03/10	1
DN10 (⅜")	CSF16/CSF16T					CSF16-SF 04/10	1
DN15 (½")	CSF16/CSF16T	CSF16-SF 04/20	1				
DN20 (¾")	CSF16/CSF16T	CSF16-SF 05/20	1				
DN25 (1")	CSF16/CSF16T	CSF16-SF 05/25	1				
DN32 (1¼")	CSF16/CSF16T	CSF16-SF 07/25	1				
DN40 (1½")	CSF16/CSF16T	CSF16-SF 07/30	1				
DN50 (2")	CSF16L/CSF16LT	CSF16-SF 10/30	1				
	CSF16H/CSF16HT	CSF16-SF 15/30	1				
DN65 (2½")	CSF16/CSF16T	CSF16-SF 20/30	1				
DN80 (3")	CSF16L/CSF16LT	CSF16-SF 30/30	1				
	CSF16H/CSF16HT	CSF16-SF 30/50	1				
DN100 (4")	CSF16L/CSF16LT	Stainless steel Steel/ PTFE Spiral Wound Gasket	Fluoraz			CSF16-SF 20/30	3
	CSF16H/CSF16HT					CSF16-SF 30/30	3
DN150 (6")	CSF16L/CSF16LT			CSF16-SF 30/30	4		

CSF16 and CSF16T Stainless Steel Steam and Sterile Air Filters

CSF16 and CSF16T filter housing options and corresponding filter elements

Filter housing			Sterile Air Filter Element		
Filter housing size	Filter housing code	Filter housing seal material	0.01 micron O-ring seal type	Filter element code	No. of elements per housing
DN8 (1/4")	CSF16/CSF16T	EPM	EPM	CSF16-A 03/10	1
DN10 (3/8")	CSF16/CSF16T			CSF16-A 04/10	1
DN15 (1/2")	CSF16/CSF16T			CSF16-A 04/20	1
DN20 (3/4")	CSF16/CSF16T			CSF16-A 05/20	1
DN25 (1")	CSF16/CSF16T			CSF16-A 05/25	1
DN32 (1 1/4")	CSF16/CSF16T			CSF16-A 07/25	1
DN40 (1 1/2")	CSF16/CSF16T			CSF16-A 07/30	1
DN50 (2")	CSF16L/CSF16LT			CSF16-A 10/30	1
	CSF16H/CSF16HT			CSF16-A 15/30	1
DN65 (2 1/2")	CSF16/CSF16T			CSF16-A 20/30	1
DN80 (3")	CSF16L/CSF16LT			CSF16-A 30/30	1
	CSF16H/CSF16HT			CSF16-A 30/50	1
DN100 (4")	CSF16L/CSF16LT			Stainless Steel/ PTFE Spiral Wound Gasket	CSF16-A 20/30
	CSF16H/CSF16HT	CSF16-A 30/30	3		
DN150 (6")	CSF16L/CSF16LT	CSF16-A 30/30	4		

Refer to sections 2.3 and 2.4 (pressure/temperature tables) to ensure the correct filter element is selected relative to the design reference of the filter housing.

Steam filter

The CSF16 and CSF16T, when fitted with a 5 micron element, are capable of removing 95% of particles 2 microns and larger in size, when installed in accordance with the requirements for the production of culinary steam to 3A accepted practice number 609-03. Accepted in the U.S. Department of Agriculture for use in federally inspected meat and poultry plants. See section 3.2 (Fig 2).

Sterile air filter

The CSF16 and CSF16T, replaceable borosilicate depth filter elements are available with a retention rate of greater than 99.9998% related to 0.01 micron.

Standards

The filter housings fully comply with the requirements of the EU Pressure Equipment Directive/UK Pressure Equipment (Safety) Regulations and carry the  mark when so required.

The CSF16/CSF16T steam filters also comply with other country specific approvals.

When fitted with a 5 micron element, are capable of removing 95% of particles 2 microns and larger in size, in accordance with the requirements for the production of culinary steam to 3A accepted practice number 609-03. Accepted in the U.S. Department of Agriculture for use in federally inspected meat and poultry plants. See section 3.2 (Fig 2). All materials meet the requirements as stipulated by the US FDA Title 21 of Code of Federal Regulations.

All constituent materials and the finished product comply with EC1935:2004 and EC2023:2006

The complete product and component parts are, manufactured, assembled, tested and packaged in a facility verified and approved by an accredited registered body to ISO 9001:2015.

Certification

The CSF16/CSF16T can be supplied with material certification as per the table below.

Note: All certification/inspection requirements must be stated at the time of order placement.

Housing PED Category (SEP, Category I, Category II)	EN10204 Inspection Documents
SEP	No certification supplied
Cat. I	No certification supplied
Cat. II	Type 3.1 (Inspection Certificate)

If type 3.1 certification is required for SEP or Cat. I Filter Housings, this must be ordered separately.

If type 3.1 certification is required for the steam filter elements, this must be ordered separately.

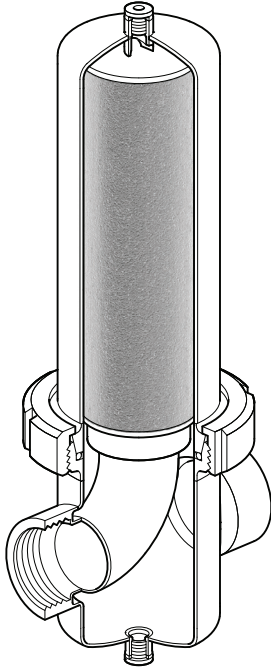

DN8 to DN80

Stainless steel steam filters

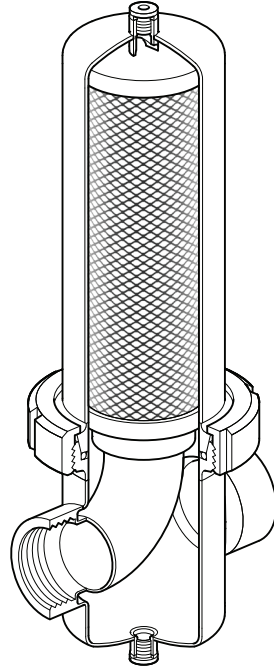

DN8 to DN80

Stainless steel sterile air filters

Supply

The CSF16 and CSF16T are supplied in two parts:

1. The filter housing head and bowl with housing seal packed in one box.
2. The filter element(s) complete with seals are supplied in separate boxes (ordered separately)

DN100 - DN150 CSF16 and CSF16T have multiple elements - See tables on pages 11 and 12.

Note - For additional information see the following Technical Information Sheets:

- TI-P180-43 for steam filters.
- TI-P180-44 for sterile air filters.

2.2 Sizes and pipe connections

Refer to Filter Housings Options Matrix in section 2.1

Stainless Steel Steam Filters

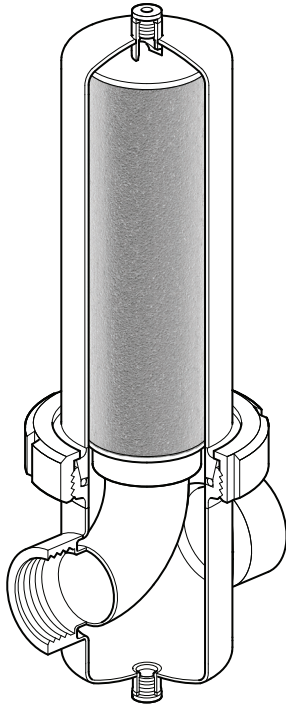

DN8 to DN80

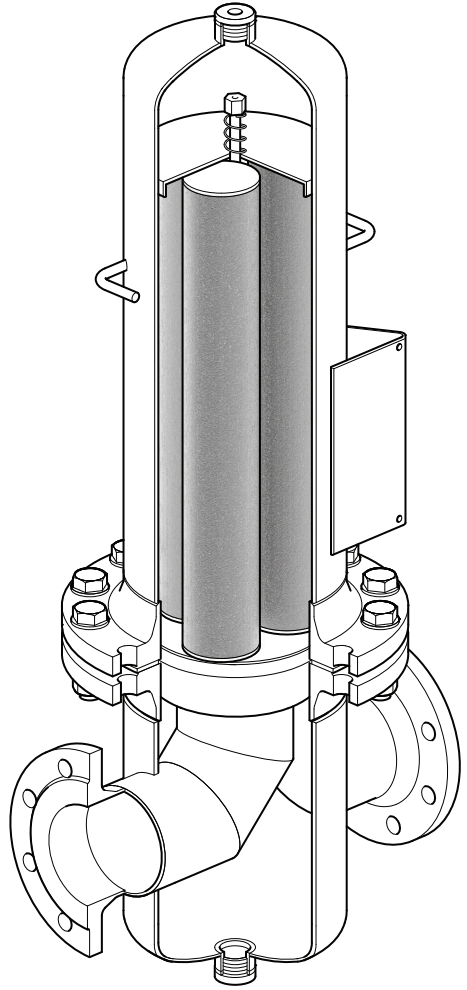

DN100 and DN150

Stainless Steel Sterile Air Filters

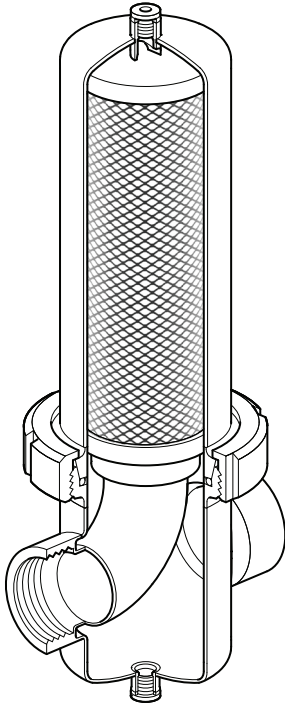

DN8 to DN80

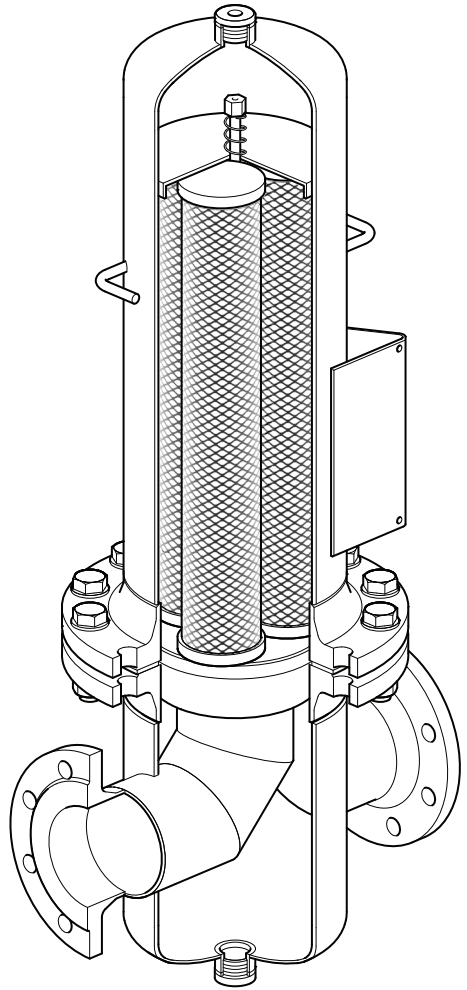



DN100 and DN150

2.3 Pressure/temperature limits for steam applications

Product Design Reference 1

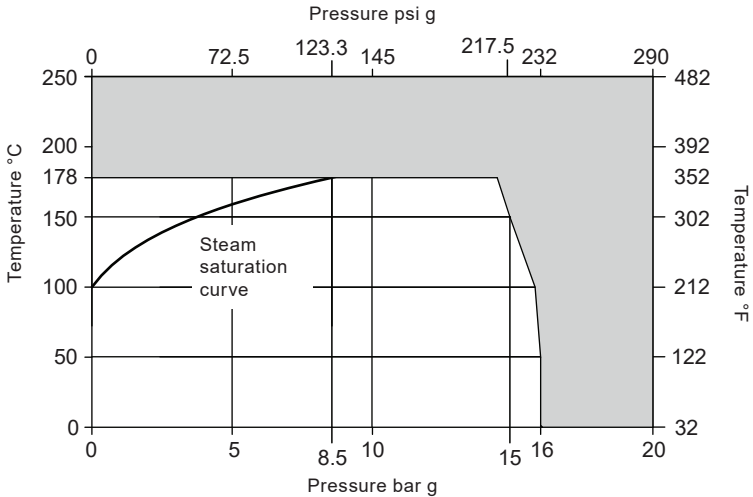
Pressure/temperature rating		PN16	
PMA	Maximum allowable pressure	16 bar g	232 psi g
TMA	Maximum allowable temperature	178 °C	352 °F
PMO	Maximum operating pressure for saturated steam service	8.5 bar g	123.3 psi g
TMO	Maximum operating temperature for saturated steam service	178 °C	352 °F
Minimum allowable temperature		-5 °C	23 °F
Minimum operating temperature		0 °C	32 °F
Cold hydraulic test pressure		26.1 bar g	379 psi g





 The product **must not** be used in this region.

2.3 Pressure/temperature limits for steam applications (continued)

Product Design Reference 2

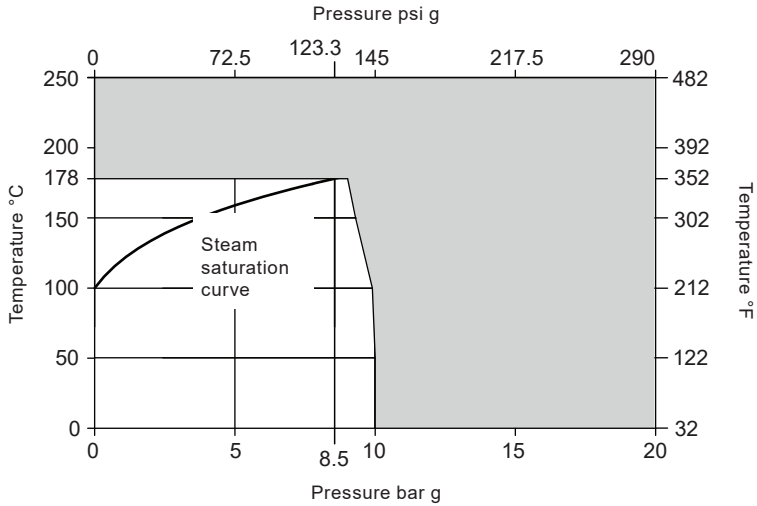
Pressure/temperature rating		PN10	
PMA	Maximum allowable pressure	10 bar g	145 psi g
TMA	Maximum allowable temperature	178 °C	352 °F
PMO	Maximum operating pressure for saturated steam service	8.5 bar g	123.3 psi g
TMO	Maximum operating temperature for saturated steam service	178 °C	352 °F
Minimum allowable temperature		-5 °C	23 °F
Minimum operating temperature		0 °C	32 °F
Cold hydraulic test pressure		16.3 bar g	236 psi g





 The product **must not** be used in this region.

2.3 Pressure/temperature limits for steam applications (continued)

Product Design Reference 3

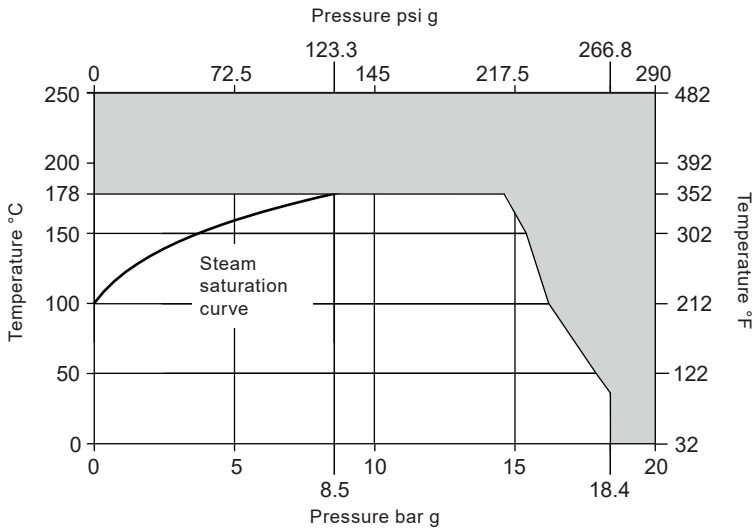
Pressure/temperature rating		Class 150	
PMA	Maximum allowable pressure	18.4 bar g	266.8 psi g
TMA	Maximum allowable temperature	178 °C	352 °F
PMO	Maximum operating pressure for saturated steam service	8.5 bar g	123.3 psi g
TMO	Maximum operating temperature for saturated steam service	178 °C	352 °F
Minimum allowable temperature		-5 °C	23 °F
Minimum operating temperature		0 °C	32 °F
Cold hydraulic test pressure		28 bar g	406 psi g





 The product **must not** be used in this region.

2.3 Pressure/temperature limits for steam applications (continued)

Product Design Reference 4

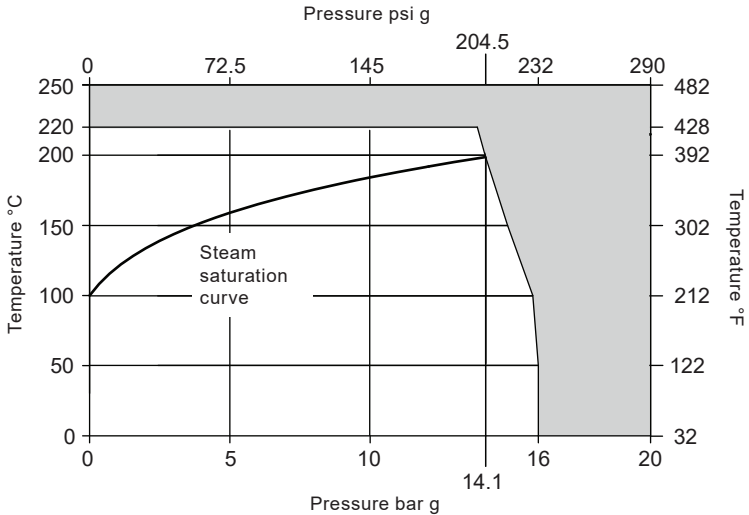
Pressure/temperature rating		PN16	
PMA	Maximum allowable pressure	16 bar g	232 psi g
TMA	Maximum allowable temperature	220 °C	428 °F
PMO	Maximum operating pressure for saturated steam service	14.1 bar g	204.5 psi g
TMO	Maximum operating temperature for saturated steam service	198.6 °C	389.4 °F
Minimum allowable temperature		-5 °C	23 °F
Minimum operating temperature		0 °C	32 °F
Cold hydraulic test pressure		26.1 bar g	379 psi g





 The product **must not** be used in this region.

2.3 Pressure/temperature limits for steam applications (continued)

Product Design Reference 5

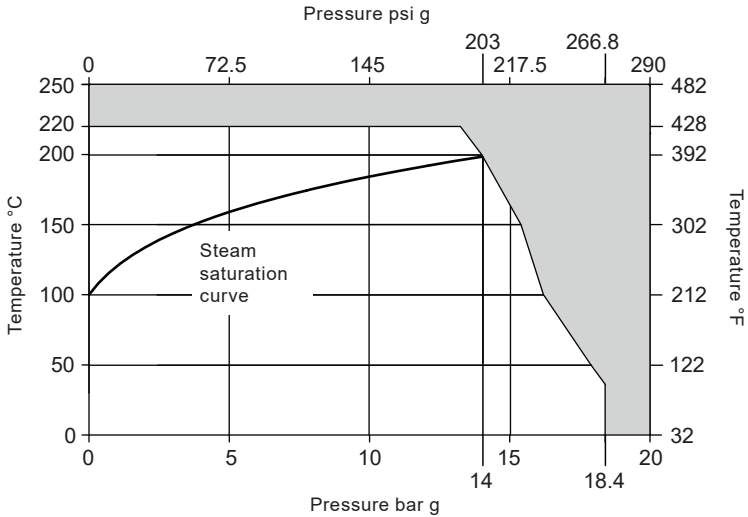
Pressure/temperature rating		Class 150	
PMA	Maximum allowable pressure	18.4 bar g	266.8 psi g
TMA	Maximum allowable temperature	220 °C	428 °F
PMO	Maximum operating pressure for saturated steam service	14 bar g	203 psi g
TMO	Maximum operating temperature for saturated steam service	198.3 °C	388.9 °F
Minimum allowable temperature		-5 °C	23 °F
Minimum operating temperature		0 °C	32 °F
Cold hydraulic test pressure		28 bar g	406 psi g





 The product **must not** be used in this region.

2.3 Pressure/temperature limits for steam applications (continued)

Product Design Reference 6

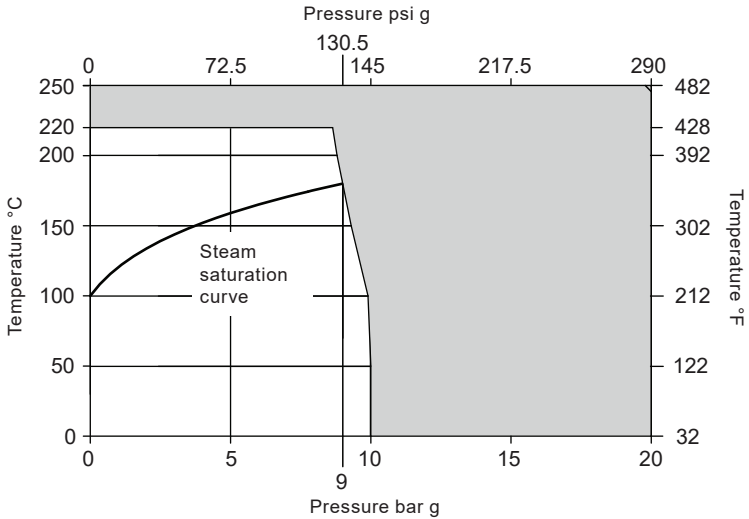
Pressure/temperature rating		PN10	
PMA	Maximum allowable pressure	10 bar g	145 psi g
TMA	Maximum allowable temperature	220 °C	428 °F
PMO	Maximum operating pressure for saturated steam service	9 bar g	130.5 psi g
TMO	Maximum operating temperature for saturated steam service	180 °C	356 °F
Minimum allowable temperature		-5 °C	23 °F
Minimum operating temperature		0 °C	32 °F
Cold hydraulic test pressure		16.3 bar g	236 psi g





 The product **must not** be used in this region.

2.3 Pressure/temperature limits for steam applications (continued)

Product Design Reference 7

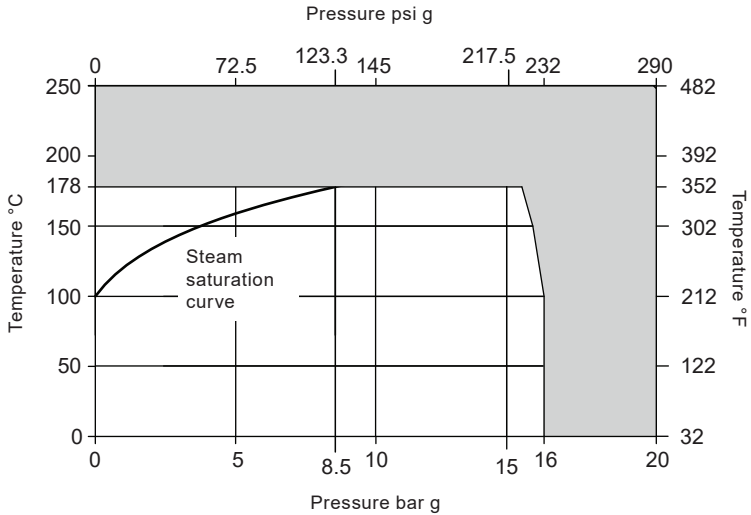
Pressure/temperature rating		PN16	
PMA	Maximum allowable pressure	16 bar g	232 psi g
TMA	Maximum allowable temperature	178 °C	352 °F
PMO	Maximum operating pressure for saturated steam service	8.5 bar g	123.3 psi g
TMO	Maximum operating temperature for saturated steam service	178 °C	352 °F
Minimum allowable temperature		-5 °C	23 °F
Minimum operating temperature		0 °C	32 °F
Cold hydraulic test pressure		25.5 bar g	370 psi g





 The product **must not** be used in this region.

2.3 Pressure/temperature limits for steam applications (continued)

Product Design Reference 8

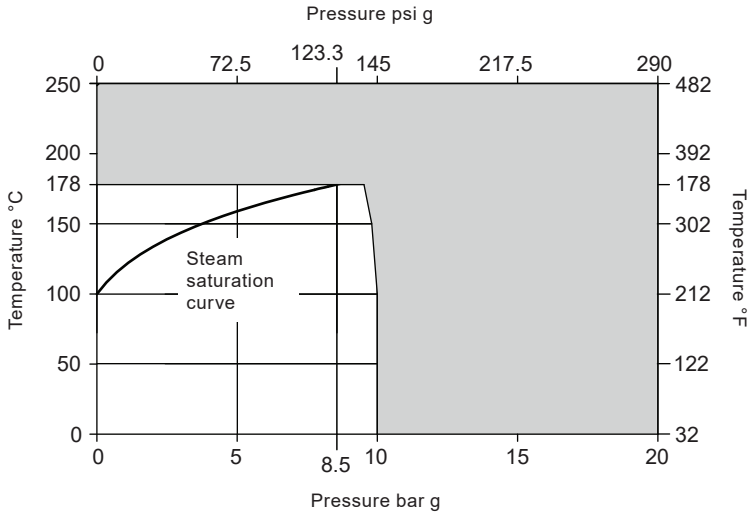
Pressure/temperature rating		PN10	
PMA	Maximum allowable pressure	10 bar g	145 psi g
TMA	Maximum allowable temperature	178 °C	352 °F
PMO	Maximum operating pressure for saturated steam service	8.5 bar g	123.3 psi g
TMO	Maximum operating temperature for saturated steam service	178 °C	352 °F
Minimum allowable temperature		-5 °C	23 °F
Minimum operating temperature		0 °C	32 °F
Cold hydraulic test pressure		15.9 bar g	231 psi g





 The product **must not** be used in this region.

2.3 Pressure/temperature limits for steam applications (continued)

Product Design Reference 9

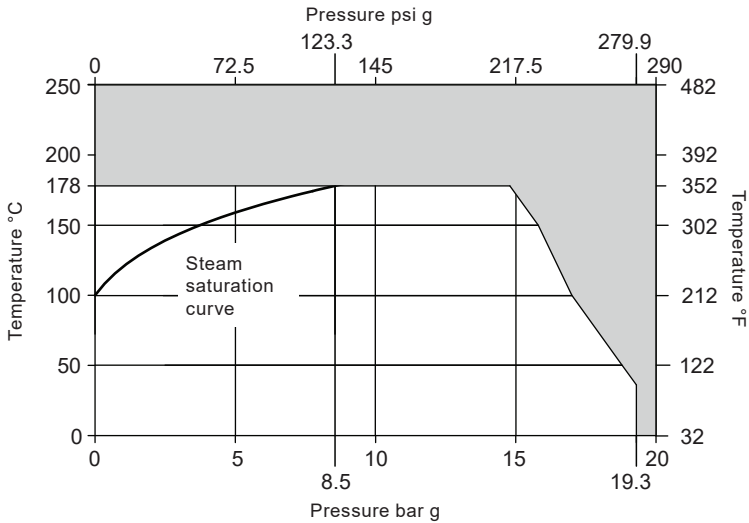
Pressure/temperature rating		Class 150	
PMA	Maximum allowable pressure	19.3 bar g	279.9 psi g
TMA	Maximum allowable temperature	178 °C	352 °F
PMO	Maximum operating pressure for saturated steam service	8.5 bar g	123.3 psi g
TMO	Maximum operating temperature for saturated steam service	178 °C	352 °F
Minimum allowable temperature		-5 °C	23 °F
Minimum operating temperature		0 °C	32 °F
Cold hydraulic test pressure		29 bar g	421 psi g





 The product **must not** be used in this region.

2.3 Pressure/temperature limits for steam applications (continued)

Product Design Reference 10

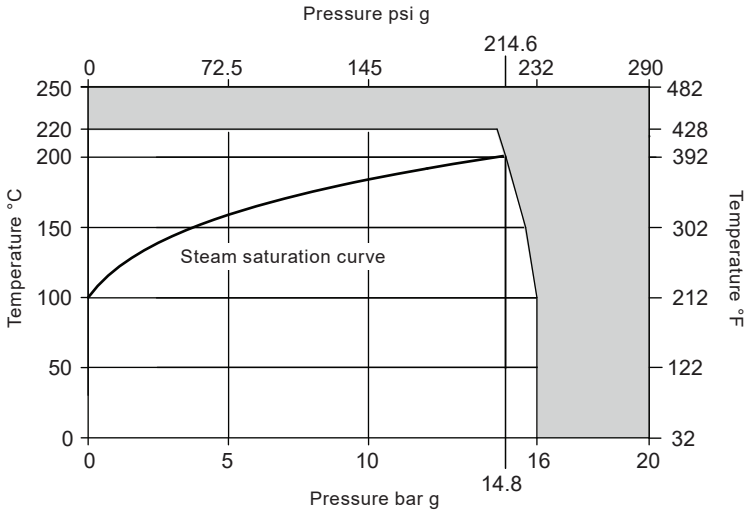
Pressure/temperature rating		PN16	
PMA	Maximum allowable pressure	16 bar g	232 psi g
TMA	Maximum allowable temperature	220 °C	428 °F
PMO	Maximum operating pressure for saturated steam service	14.8 bar g	214.6 psi g
TMO	Maximum operating temperature for saturated steam service	200.8 °C	393.4 °F
Minimum allowable temperature		-5 °C	23 °F
Minimum operating temperature		0 °C	32 °F
Cold hydraulic test pressure		25.5 bar g	370 psi g





 The product **must not** be used in this region.

2.3 Pressure/temperature limits for steam applications (continued)

Product Design Reference 11

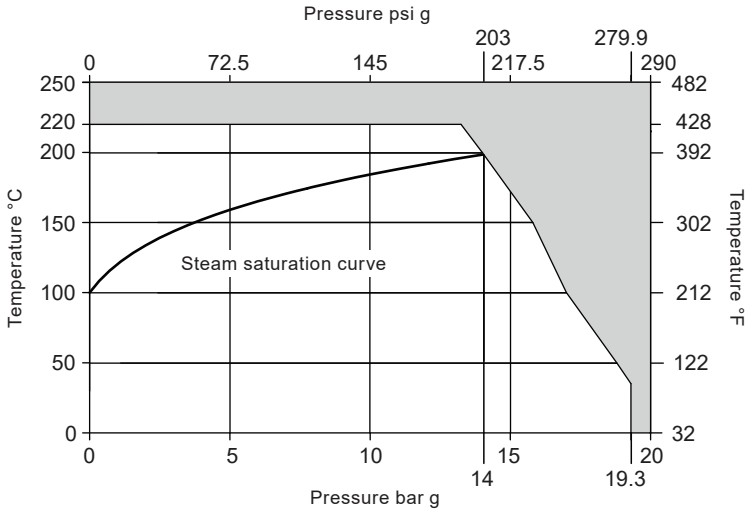
Pressure/temperature rating		Class 150	
PMA	Maximum allowable pressure	19.3 bar g	279.9 psi g
TMA	Maximum allowable temperature	220 °C	428 °F
PMO	Maximum operating pressure for saturated steam service	14 bar g	203 psi g
TMO	Maximum operating temperature for saturated steam service	198.3 °C	388.9 °F
Minimum allowable temperature		-5 °C	23 °F
Minimum operating temperature		0 °C	32 °F
Cold hydraulic test pressure		29 bar g	421 psi g



 The product **must not** be used in this region.

2.3 Pressure/temperature limits for steam applications (continued)

Product Design Reference 12

Pressure/temperature rating		PN10	
PMA	Maximum allowable pressure	10 bar g	145 psi g
TMA	Maximum allowable temperature	220 °C	428 °F
PMO	Maximum operating pressure for saturated steam service	9.4 bar g	136.3 psi g
TMO	Maximum operating temperature for saturated steam service	181.7 °C	359.1 °F
Minimum allowable temperature		-5 °C	23 °F
Minimum operating temperature		0 °C	32 °F
Cold hydraulic test pressure		15.9 bar g	231 psi g

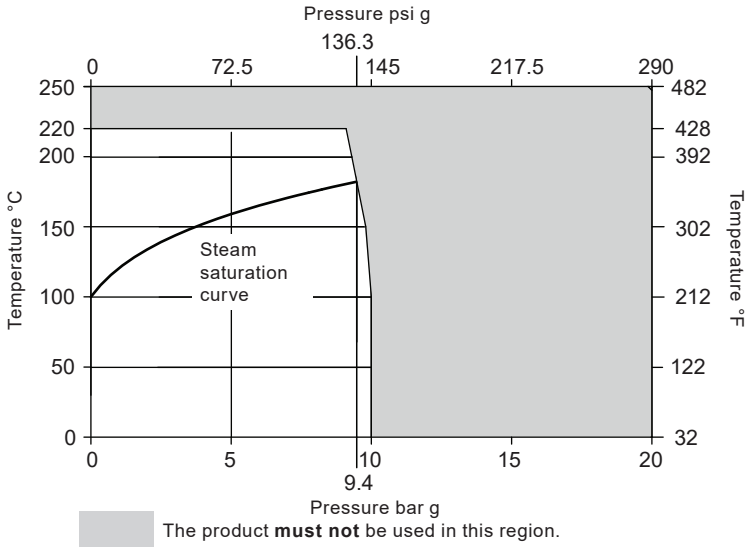

2.4 Pressure/temperature limits for sterile air applications

Product Design Reference 1

Pressure/temperature rating		PN16	
PMA	Maximum allowable pressure	16 bar g	232 psi g
TMA	Maximum allowable temperature	178 °C	352 °F
PMO	Maximum operating pressure	16 bar g	232 psi g
TMO	Maximum operating temperature	178 °C	352 °F
Minimum allowable temperature		-5 °C	23 °F
Minimum operating temperature		0 °C	32 °F
Cold hydraulic test pressure		26.1 bar g	379 psi g

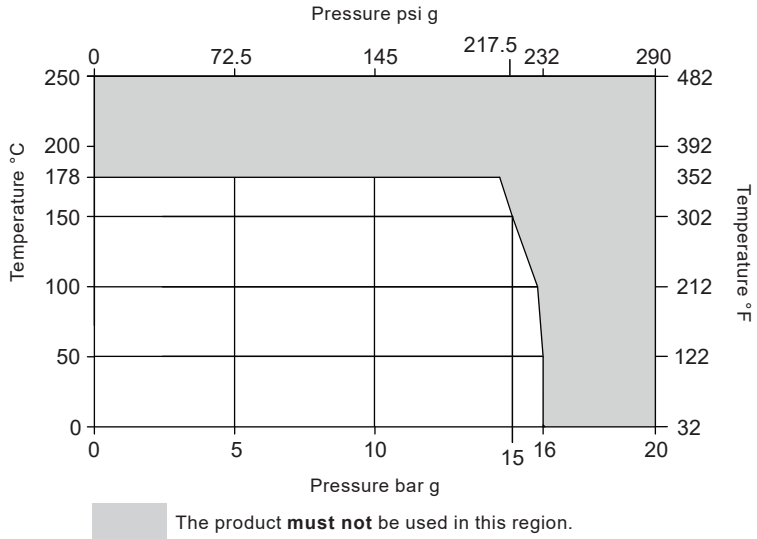

2.4 Pressure/temperature limits for sterile air applications (continued)

Product Design Reference 2

Pressure/temperature rating		PN10	
PMA	Maximum allowable pressure	10 bar g	145 psi g
TMA	Maximum allowable temperature	178 °C	352 °F
PMO	Maximum operating pressure	10 bar g	145 psi g
TMO	Maximum operating temperature	178 °C	352 °F
Minimum allowable temperature		-5 °C	23 °F
Minimum operating temperature		0 °C	32 °F
Cold hydraulic test pressure		16.3 bar g	236 psi g

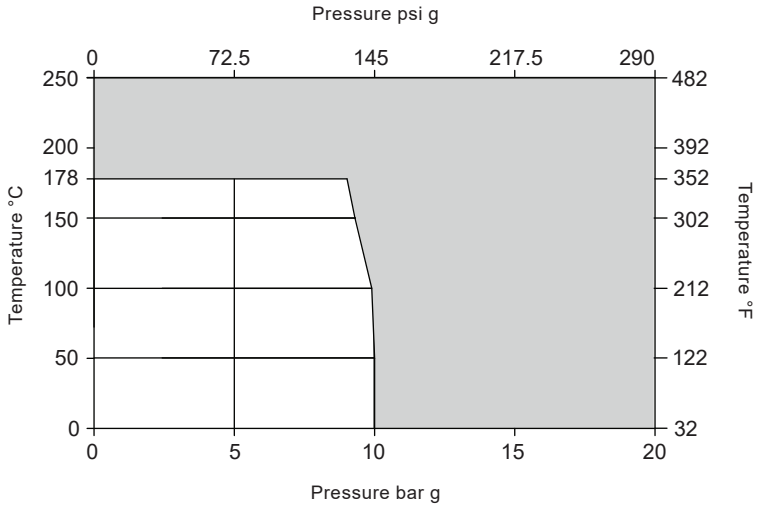



 The product **must not** be used in this region.

2.4 Pressure/temperature limits for sterile air applications (continued)

Product Design Reference 3

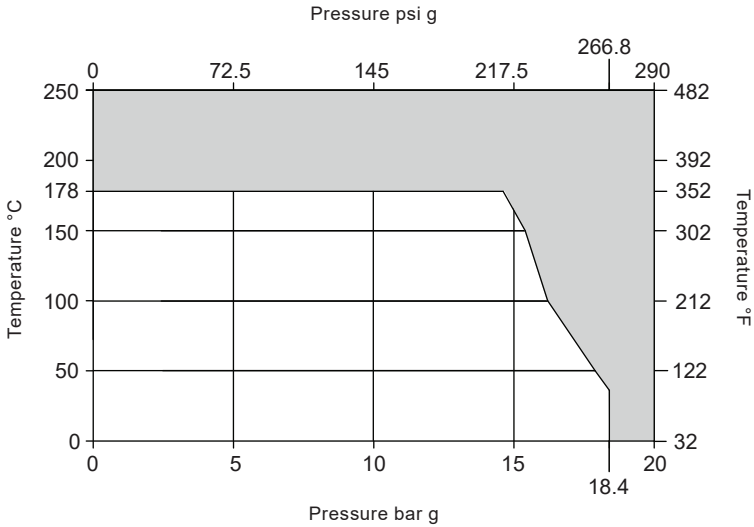
Pressure/temperature rating		Class 150	
PMA	Maximum allowable pressure	18.4 bar g	266.8 psi g
TMA	Maximum allowable temperature	178 °C	352 °F
PMO	Maximum operating pressure	18.4 bar g	266.8 psi g
TMO	Maximum operating temperature	178 °C	352 °F
Minimum allowable temperature		-5 °C	23 °F
Minimum operating temperature		0 °C	32 °F
Cold hydraulic test pressure		28 bar g	406 psi g





 The product **must not** be used in this region.

2.4 Pressure/temperature limits for sterile air applications (continued)

Product Design Reference 4

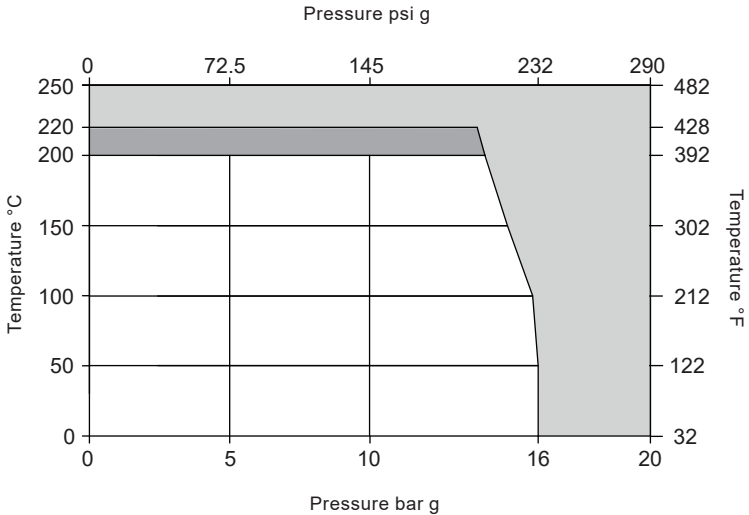
Pressure/temperature rating		PN16	
PMA	Maximum allowable pressure	16 bar g	232 psi g
TMA	Maximum allowable temperature	220 °C	428 °F
PMO	Maximum operating pressure	16 bar g	232 psi g
TMO	Maximum operating temperature	200 °C	392 °F
Minimum allowable temperature		-5 °C	23 °F
Minimum operating temperature		0 °C	32 °F
Cold hydraulic test pressure		26.1 bar g	379 psi g



 The product **must not** be used in this region.

 The product **should not** be used in this region.

2.4 Pressure/temperature limits for sterile air applications (continued)

Product Design Reference 5

Pressure/temperature rating		Class 150	
PMA	Maximum allowable pressure	18.4 bar g	266.8 psi g
TMA	Maximum allowable temperature	220 °C	428 °F
PMO	Maximum operating pressure	18.4 bar g	266.8 psi g
TMO	Maximum operating temperature	200 °C	392 °F
Minimum allowable temperature		-5 °C	23 °F
Minimum operating temperature		0 °C	32 °F
Cold hydraulic test pressure		28 bar g	406 psi g

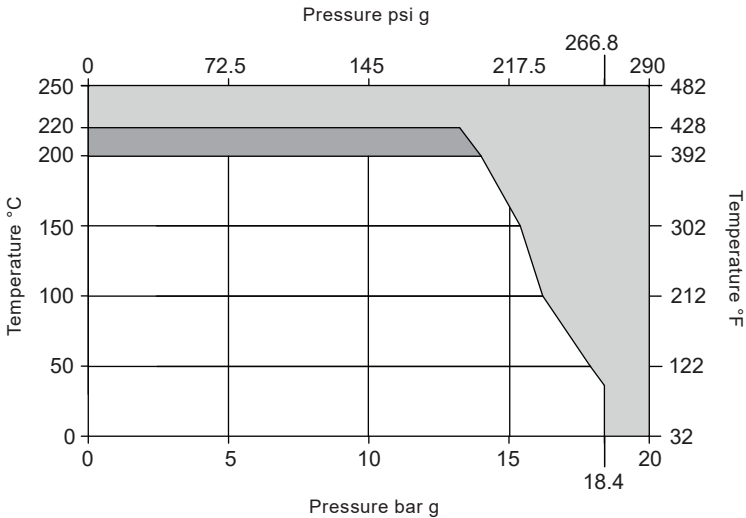

 The product **must not** be used in this region.

 The product **should not** be used in this region.

2.4 Pressure/temperature limits for sterile air applications (continued)

Product Design Reference 6

Pressure/temperature rating		PN10	
PMA	Maximum allowable pressure	10 bar g	145 psi g
TMA	Maximum allowable temperature	220 °C	428 °F
PMO	Maximum operating pressure	10 bar g	145 psi g
TMO	Maximum operating temperature	200 °C	392 °F
Minimum allowable temperature		-5 °C	23 °F
Minimum operating temperature		0 °C	32 °F
Cold hydraulic test pressure		16.3 bar g	236 psi g

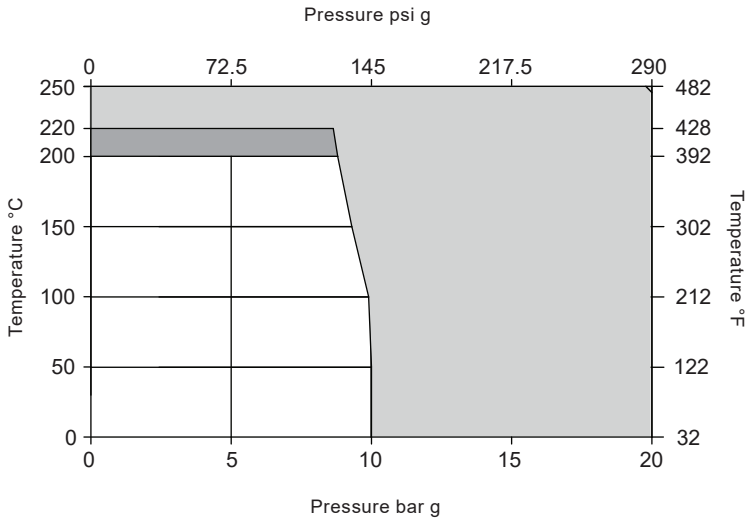

 The product **must not** be used in this region.

 The product **should not** be used in this region.

2.4 Pressure/temperature limits for sterile air applications (continued)

Product Design Reference 7

Pressure/temperature rating		PN16	
PMA	Maximum allowable pressure	16 bar g	232 psi g
TMA	Maximum allowable temperature	178 °C	352 °F
PMO	Maximum operating pressure	16 bar g	232 psi g
TMO	Maximum operating temperature	178 °C	352 °F
Minimum allowable temperature		-5 °C	23 °F
Minimum operating temperature		0 °C	32 °F
Cold hydraulic test pressure		25.5 bar g	370 psi g

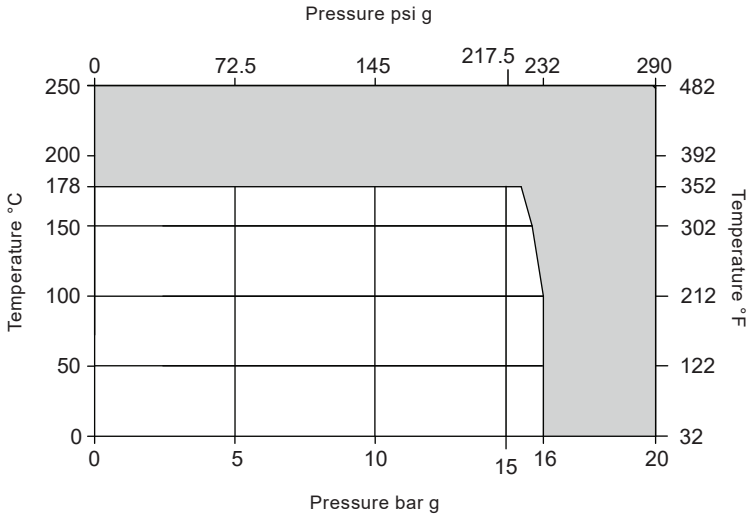



 The product **must not** be used in this region.

2.4 Pressure/temperature limits for sterile air applications (continued)

Product Design Reference 8

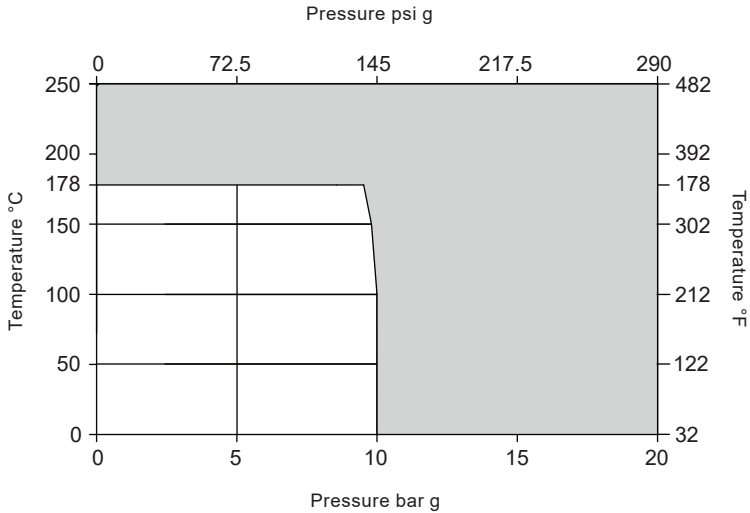
Pressure/temperature rating		PN10	
PMA	Maximum allowable pressure	10 bar g	145 psi g
TMA	Maximum allowable temperature	178 °C	352 °F
PMO	Maximum operating pressure	10 bar g	145 psi g
TMO	Maximum operating temperature	178 °C	352 °F
Minimum allowable temperature		-5 °C	23 °F
Minimum operating temperature		0 °C	32 °F
Cold hydraulic test pressure		15.9 bar g	231 psi g





 The product **must not** be used in this region.

2.4 Pressure/temperature limits for sterile air applications (continued)

Product Design Reference 9

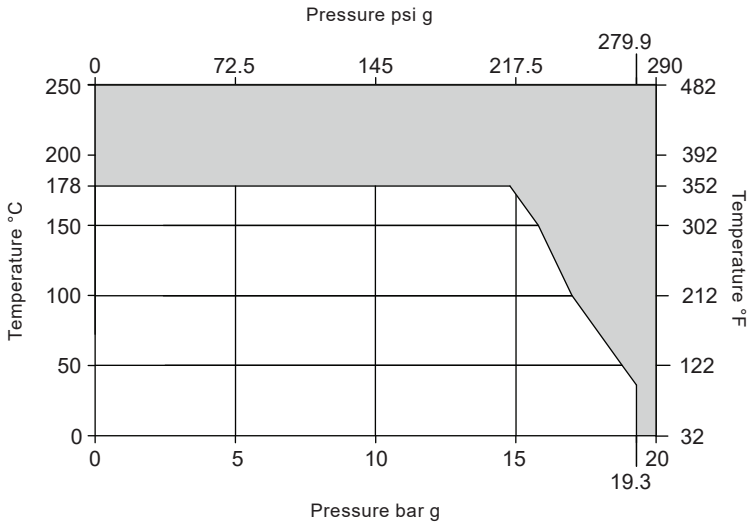
Pressure/temperature rating		Class 150	
PMA	Maximum allowable pressure	19.3 bar g	279.9 psi g
TMA	Maximum allowable temperature	178 °C	352 °F
PMO	Maximum operating pressure	19.3 bar g	279.9 psi g
TMO	Maximum operating temperature	178 °C	352 °F
Minimum allowable temperature		-5 °C	23 °F
Minimum operating temperature		0 °C	32 °F
Cold hydraulic test pressure		29 bar g	421 psi g





 The product **must not** be used in this region.

2.4 Pressure/temperature limits for sterile air applications (continued)

Product Design Reference 10

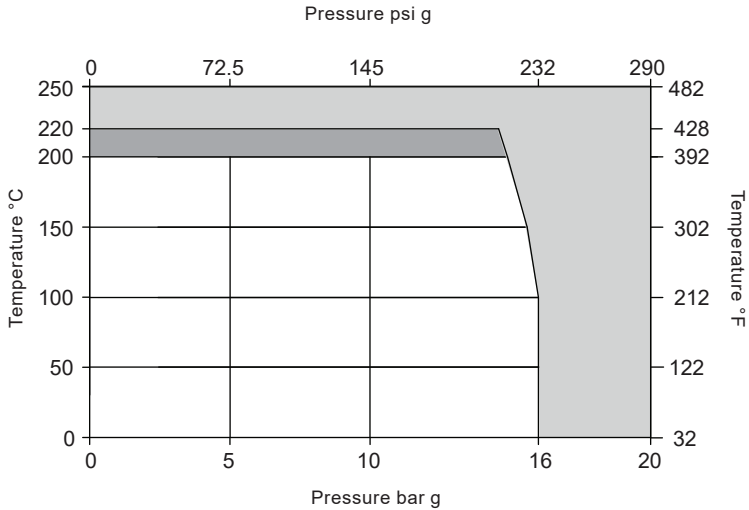
Pressure/temperature rating		PN16	
PMA	Maximum allowable pressure	16 bar g	232 psi g
TMA	Maximum allowable temperature	220 °C	428 °F
PMO	Maximum operating pressure	16 bar g	232 psi g
TMO	Maximum operating temperature	200 °C	392 °F
Minimum allowable temperature		-5 °C	23 °F
Minimum operating temperature		0 °C	32 °F
Cold hydraulic test pressure		25.5 bar g	370 psi g



 The product **must not** be used in this region.

 The product **should not** be used in this region.

2.4 Pressure/temperature limits for sterile air applications (continued)

Product Design Reference 11

Pressure/temperature rating		Class 150	
PMA	Maximum allowable pressure	19.3 bar g	279.9 psi g
TMA	Maximum allowable temperature	220 °C	428 °F
PMO	Maximum operating pressure	19.3 bar g	279.9 psi g
TMO	Maximum operating temperature	200 °C	392 °F
Minimum allowable temperature		-5 °C	23 °F
Minimum operating temperature		0 °C	32 °F
Cold hydraulic test pressure		29 bar g	421 psi g

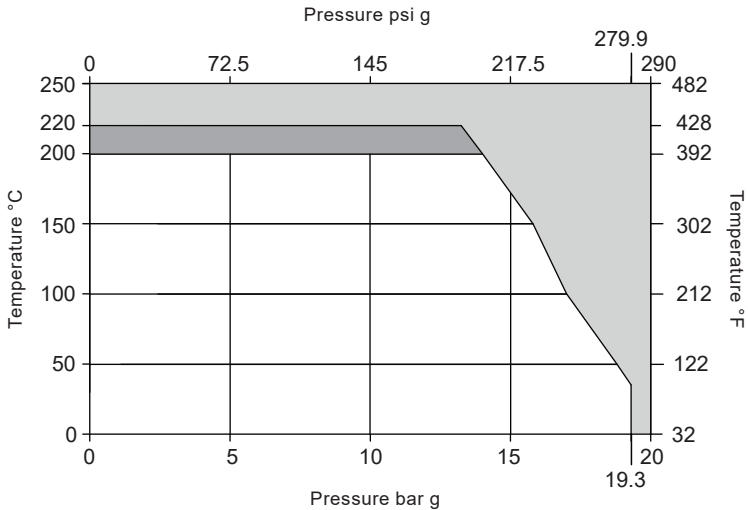

 The product **must not** be used in this region.

 The product **should not** be used in this region.

2.4 Pressure/temperature limits for sterile air applications (continued)

Product Design Reference 12

Pressure/temperature rating		PN10	
PMA	Maximum allowable pressure	10 bar g	145 psi g
TMA	Maximum allowable temperature	220 °C	428 °F
PMO	Maximum operating pressure	10 bar g	145 psi g
TMO	Maximum operating temperature	200 °C	392 °F
Minimum allowable temperature		-5 °C	23 °F
Minimum operating temperature		0 °C	32 °F
Cold hydraulic test pressure		15.9 bar g	231 psi g

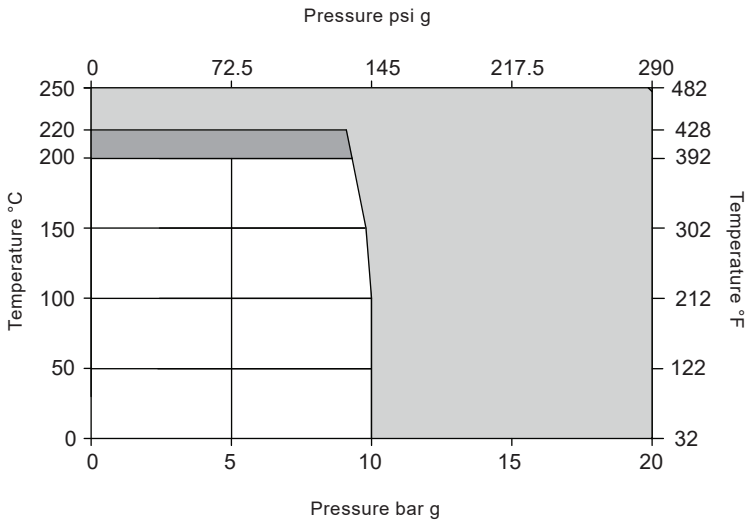

 The product **must not** be used in this region.

 The product **should not** be used in this region.

3. Installation

Note: Before commencing any installation observe the 'Safety information' in Section 1.

Referring to the Installation and Maintenance Instructions, name-plate and Technical Information Sheet, check that the product is suitable for the intended installation:

3.1 Supply

The CSF16 and CSF16T filter housings are supplied separately to the filter elements.

1. The filter housing head and bowl with housing seal or gasket are packed in one carton, complete with EN 10204 3.1 certification where applicable and Installation and Maintenance Instructions.
2. The filter element complete with two seals.
Note: DN100 and DN150 CSF16 and CSF16T require multiple elements – see filter element selection table.

3.2 Installation

There are 6 main criteria which need to be met in order to ensure that the CSF16 and CSF16T filters works effectively and for a long trouble free life.

1. When used on steam or compressed air services a separator should be installed upstream of the filter to remove droplets of condensate held in suspension. Not only will this help the condition of the steam or compressed air but it will also prolong the life of the filter element. For certain applications, such as culinary steam a separator is mandatory in order to comply with sanitary standards. We recommend that the filter housings are installed as per the 3A best practice guidelines REF 3-A Accepted Practices for A Method of Producing Culinary Steam, Number 609-03.
2. It is recommended that for maximum service life a Y-type strainer complete with 100 mesh stainless steel screen is installed upstream of the CSF16 and CSF16T.
3. The filter housing must be installed in horizontal pipework with the filter head vertically above the interconnecting pipes. DN100 and DN150 CSF16 and CSF16T have multiple elements, see table 2 for further information.
4. Make sure the filter housing is installed with the directional arrows pointing in line with the direction of flow in the pipework.
5. When used on steam the drain plug and gasket on the filter bowl should be removed and a steam trap installed below the filter. The condensate from this trap should be piped away to drain, or to the receiver of a pump, providing there is no backpressure, i.e. lift, is imposed upon the steam trap (see Figure 5). If it is not possible to install a steam trap at the drain point, then a full size equal tee drain point or inline separator with suitable steam trap should be incorporated into the horizontal pipework prior to the filter. It is recommended that an air vent is fitted to the top connection on the filter head.
6. Pressure gauges should be installed before and after the filter to check the differential pressure across the filter itself. Once the differential pressure reaches 0.7 bar g (10 psi g) the filter element should be replaced.

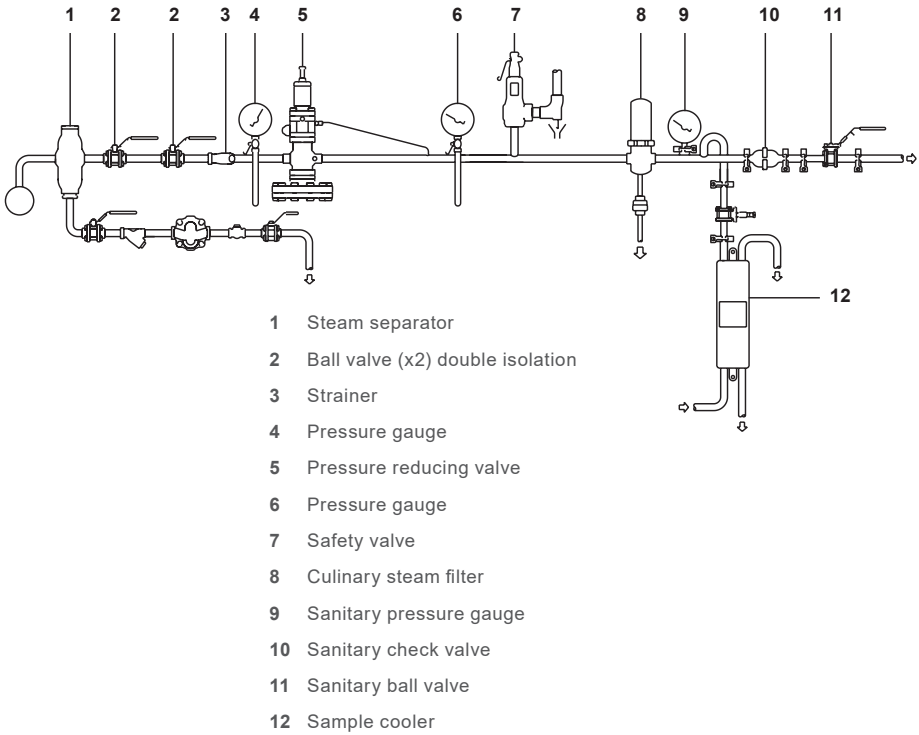

Fig. 2 Typical filtered steam station

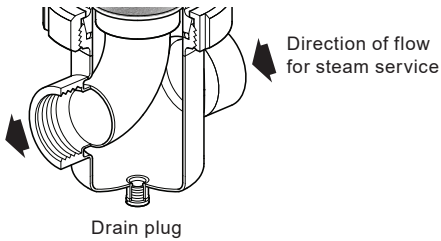

Fig. 3 Steam filter - DN8 to DN80

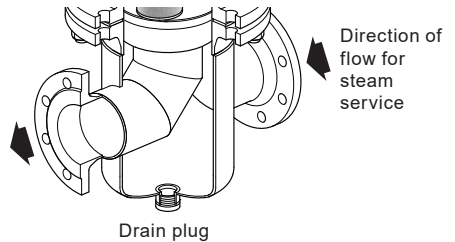

Fig. 4 Steam filter - DN100 and DN150

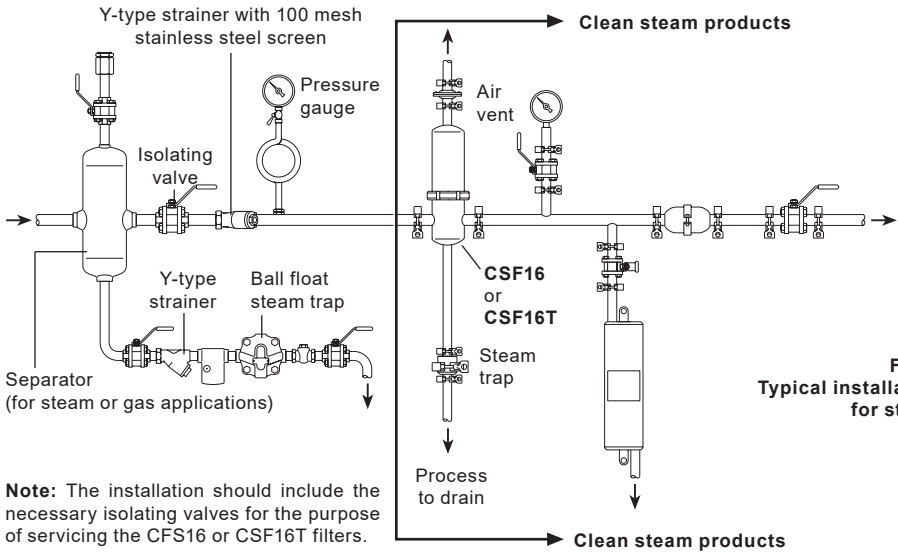

Fig. 5
Typical installation for steam

Note: The installation should include the necessary isolating valves for the purpose of servicing the CFS16 or CFS16T filters.

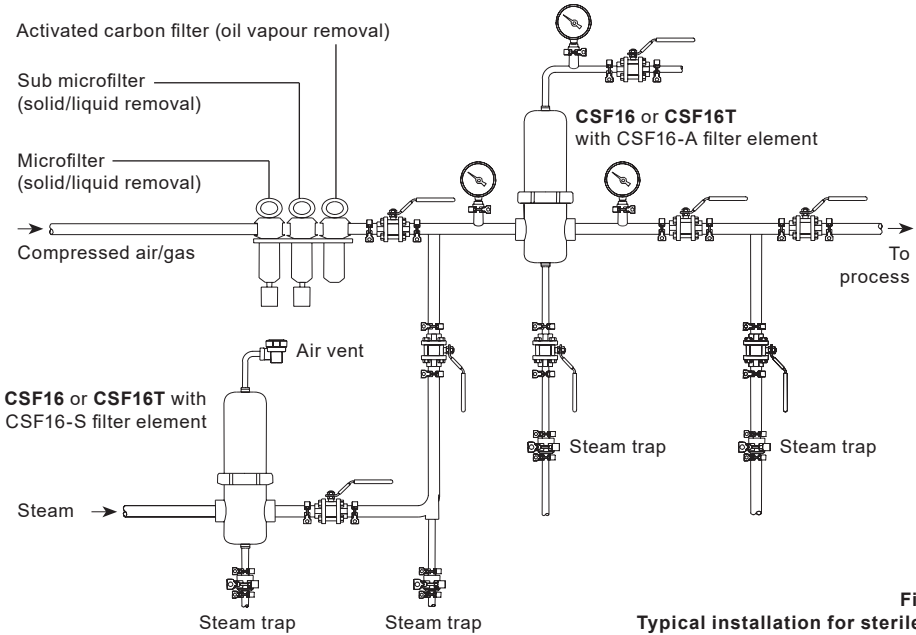

Fig. 6
Typical installation for sterile air

CSF16 and CSF16T Stainless Steel Steam and Sterile Air Filters



4. Commissioning

Once the pipework installation has been completed in accordance with Section 3 (Fig. 5 or 6) the following steps should be taken in sequence, referencing Fig. 7 and 8, to commission the CSF16 and CSF16T filters:

Note: The top and bottom plugs (where supplied) are hand tightened only. If an air vent and trap are not connected as per the recommended installation guidance above, ensure that the plugs are tightened to the torque values shown in the torque table 1.

1. All isolating valves should be closed.
 2. The housing ring (4) or housing bolts (10) holding together the filter housing head (2) and the filter housing bowl (1) should be unscrewed using the appropriate spanner. The filter housing head (2) can then be removed.
 3. The filter element seals (2 off, item 6) should then be lubricated using a lubricant suitable for the application, before fitting to the filter housing bowl (1).
 4. The filter element (5 - please note that there are multiple elements for the larger sizes) needs to be gently pushed into the filter housing bowl (1).
 5. **When multiple elements are fitted**, the filter support assembly (11) must be assembled and fitted as shown in Fig. 8.
 6. Ensure the filter housing seal (3) is fitted.
 7. **For sizes DN8 to DN80:** The housing ring (4) should then be carefully placed into the seating land on the filter housing head (2), before then gently lowering the filter housing bowl (1) over the filter element and tightening the housing ring (4). The housing ring (4) is designed with a coarse thread to minimise the possibility of galling. Thread lubrication is not normally necessary. However, a thread lubricant may be used if required.
- For sizes DN100 and DN150:** Gently lower the housing head (2) over the filter elements and place it onto the housing bowl (1). Tighten the housing bolts to the recommended torque - See Table 1.
8. Once Steps 1-7 have been completed the upstream isolating valve can be cracked open slowly to introduce the medium into the CSF16 or CSF16T filter then proceed with Steps 8 to 12, page 14.

Table 1 Recommended tightening torques

Item	Part	 or 	mm	N m
4		use C spanner		As required
7	DN8 - DN80	6 mm Hex	G¼"	55
	DN100 and DN150L	A/F 42	G1"	138
10	DN100	A/F 30	M20	180
	DN150L	A/F 30	M20	260

Stainless Steel Steam Filters

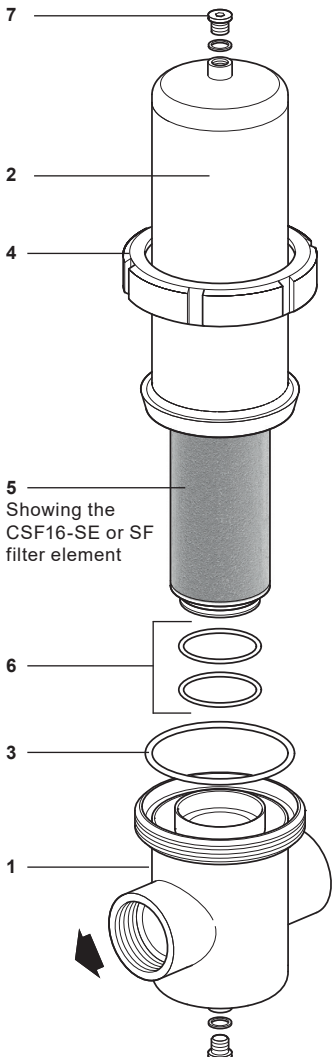

Fig. 7 DN8 to DN80

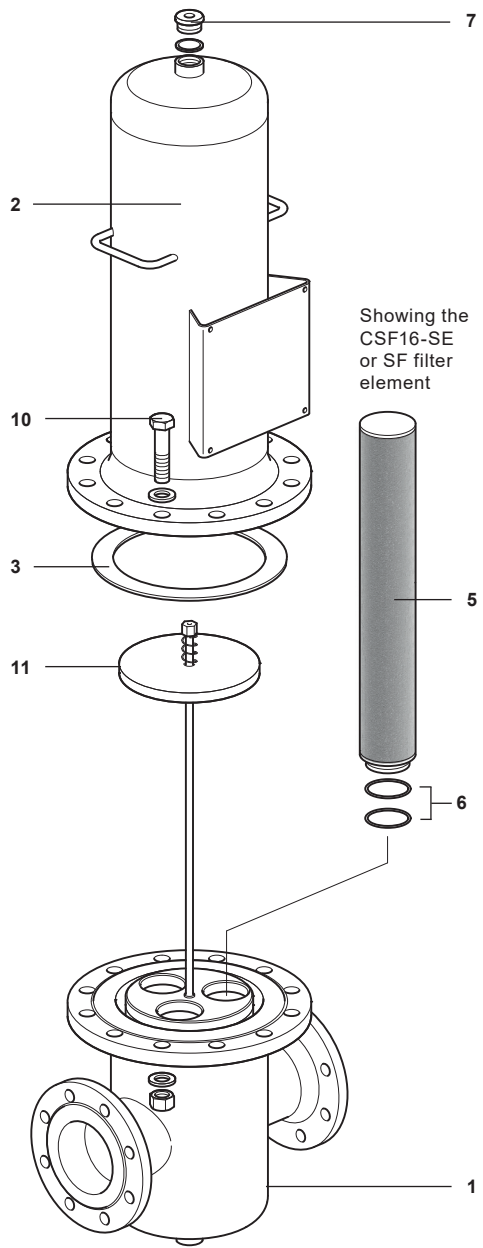

Fig. 8 DN100 and DN150L
(image shows DN100L)

CSF16 and CSF16T Stainless Steel Steam and Sterile Air Filters

9. If on gas or steam service an audible signal (whistling tone) is heard then the filter housing has been incorrectly assembled and the upstream isolating valve should be closed immediately.

Warning. Before opening housing ensure it has cooled and that any residual pressure within has been discharged.

Once this has happened the housing ring (4) or housing bolts (10) can be undone, the filter housing bowl and head (1 and 2) plus filter element(s) (5) can be carefully checked before reassembly.

10. **Should no audible signal be heard after the upstream isolating valve has been opened**, then the downstream valve can be opened slowly until fully open. The medium will now be flowing through the CSF16 or CSF16T filter and at this stage a note should be taken of the pressure gauge readings before and after the CSF16 or CSF16T filter, in order to check the differential pressure. The installation date should also be noted.
11. All interconnecting pipework, fixtures and fittings should then be checked for leakage especially if steam is the operating medium. This check should include steam traps.
12. **Within the first few days following commissioning of the new CSF16 or CSF16T filter**, the filter should be isolated and the strainer preceding the filter checked by removing the screen. Any pipe debris can be removed or the strainer screen can be replaced.
13. After the CSF16 or CSF16T filter has been in use for some time (determined by experience) the pressure gauges should be checked to establish the differential pressure. If this has reached 0.7 bar g (10 psi g) then the filter element(s) must be removed for replacement (see Section 6, Maintenance).

Stainless steel sterile air filters

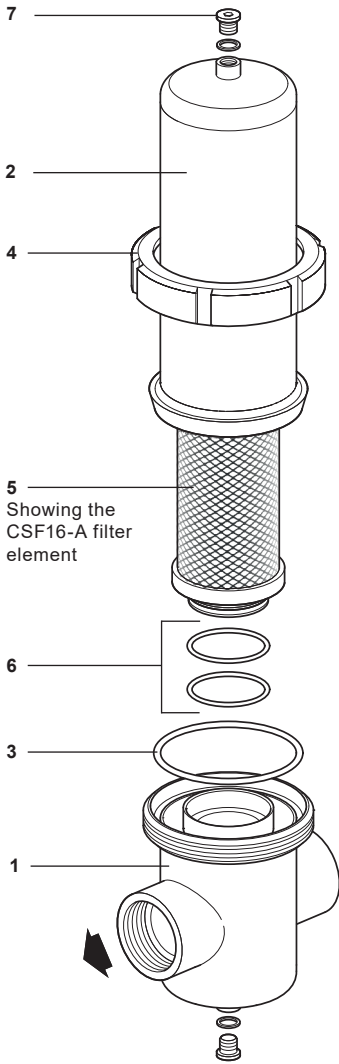

Fig. 9 DN8 to DN80

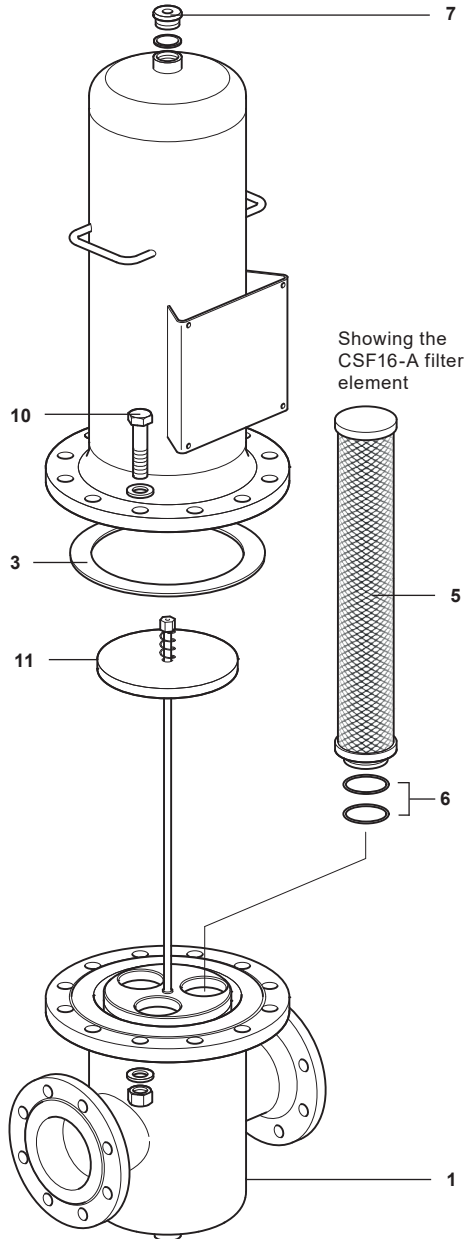

Fig. 10 DN100 and DN150L
(image shows DN100L)

CSF16 and CSF16T Stainless Steel Steam and Sterile Air Filters

5. Operation

5.1 Steam filters

The CSF16-SE and SF are sintered austenitic stainless steel filter elements with a 1, 5 or 25 micron absolute rating. They allow steam to be filtered such that all sub-visible solid and liquid particles are removed.

The rating for the filter element means that for steam and gas service 100% of liquid and gas particles larger than the rating will be retained by the filter element. In order to minimise pressure drop and extend filter element life the coarsest rating compatible with the application should be selected. As well as retaining all particles larger than the pore size, the filter element will also stop a percentage of smaller particles. For example the 1 micron filter element has an efficiency of 99.7% based on 0.2 micron particles.

Warning: The steam filter elements CSF16 -SE and CSF16 - SF must never be subjected to more than 5 bar g differential pressure.

5.2 Sterile air filters

The CSF16-A are borosilicate depth filter elements used to remove contaminate particles from compressed air systems.

Filter elements have a retention rate of >than 99.9998% related to the 0.01 µm filter element rating.

6. Maintenance

Note: Before undertaking any maintenance, observe the 'Safety information' in Section 1.

6.1 General information

Filter element type	Application	Service life	Additional notes
CSF16-SE or CSF16-SF	Steam	<p>Replace when 0.7 bar g pressure drop is measured across the filter housing</p> <p>Alternatively, where pressure drop cannot be accurately measured:</p> <p>after 12 months from installation (lowest risk) up to a maximum of 36 months*</p>	<p>Filter Housings should be Installed, Commissioned and Operated in accordance with Sections 3, 4 and 5 of this document.</p> <p>Clean Steam Filter Housings and Filter elements are manufactured in accordance with EC1935:2004 (Materials and articles intended to come into contact with food). Therefore, it is recommended that Filter elements are replaced to maintain this compliance, and not cleaned.</p> <p>Cleaning of Filter Elements is not recommended because of the increased risk of introducing contamination to the process. Cleaning will only provide a short-term improvement in dirt holding capacity and will never return to 'as new' condition.</p> <p>*Service life durations are based upon Steam Systems being regularly maintained and best practice followed.</p>
CSF16-A	Sterile Air	Replace after 100 inline sterilisation cleaning cycles**	<p>Filter Housings should be Installed, Commissioned and Operated in accordance with Sections 3, 4 and 5 of this document.</p> <p>** using filtered steam at 121 °C for 30 minutes</p>

Before undertaking any maintenance on the filter, it must be isolated from both the supply line and return line and any pressure allowed to safely normalise to atmosphere. The filter should then be allowed to cool. When reassembling, ensure that all joint faces are clean.

6.2 Filter element maintenance:

Reference Figures 9 and 10, page 15, for part recognition.

- Remove the housing ring (4) or housing bolts (10) holding together the filter housing head and bowl (2 and 1). Then proceed to remove the filter housing head (2) being careful not to damage the filter element(s).
- Remove the filter element(s) (5) carefully.

It is strongly recommended that a spare filter element set is carried in stock to minimise downtime.

Reassemble and commission following Steps 3 to 12 laid down in Section 4 'Commissioning'.

7. Spare parts

The spare parts are shown in solid outline. Parts drawn in a grey line are not supplied as spares.

7.1 Available spares

CSF16-SE and CSF16-SF filter element kit for steam applications	5, 6 (2 off) see page 52
CSF16-A filter element kit for sterile air applications	5, 6 (2 off) see page 53
CSF16-SKE or CSF16-SKF Seal kit (please see the seal kit contents table below for quantities)	3, 6

7.2 CSF16 seal kit cross reference table

Filter housing type	Filter housing sizes	For use on steam (Up to 178 °C)	For use on steam (Up to 220 °C)	For use on sterilised air
CSF16 and CSF16T	DN8 (¼") DN10 (¾")	CSF16-SKE 01	CSF16-SKF 01	CSF16-SKE 01
CSF16 and CSF16T	DN15 (½") DN20 (¾")	CSF16-SKE 02	CSF16-SKF 02	CSF16-SKE 02
CSF16 and CSF16T	DN25 (1") DN32 (1¼")	CSF16-SKE 03	CSF16-SKF 03	CSF16-SKE 03
CSF16 and CSF16T	DN40 (1½") DN50 L (2") DN50 H (2")	CSF16-SKE 04	CSF16-SKF 04	CSF16-SKE 04
CSF16 and CSF16T	DN65 (2½") DN80 L (3")	CSF16-SKE 05	CSF16-SKF 05	CSF16-SKE 05
CSF16 and CSF16T	DN80 H (3")	CSF16-SKE 06	CSF16-SKF 06	CSF16-SKE 06
CSF16 and CSF16T	DN100 L (4") DN100 H (4")		CSF16-SKF 07	CSF16-SKE 07
CSF16 and CSF16T	DN150 L (6")		CSF16-SKF 08	CSF16-SKE 08

7.3 Seal kit contents

Unit size	Housing seal (Part number 3)	Element seals (Part number 6)
DN8 to DN80H	1	2
DN100L and DN100H	1	6
DN150L	1	8

7.4 How to order spares

Always order spares by using the description given in the column headed 'Available spares' and state the size and type of filter housing.

For steam filter element kits only also quote the filter element pore size (micron) and housing /filter element seal material required. See Filter Element Cross Reference table for correct descriptions, in Section 2.

For seal kits only see Seal Kit Cross Reference table for correct descriptions (section 7 above).

CSF16 for steam applications

Example: 1 off 5 micron CSF16-SF 05/25 filter element kit for a Spirax Sarco DN25 CSF16 clean steam filter, with Fluoraz filter element seals.

Example: 1 off CSF16-SKF 03 Seal Kit for a Spirax Sarco DN25 CSF16 clean steam filter with Fluoraz seals.

CSF16 for sterile air applications

Example: 4 off CSF16-A 30/30 filter element kits for a Spirax Sarco DN150 CSF16 sterile air filter with EPM filter element seals.

Example: 1 off CSF16-SKE 08 Seal Kit for a Spirax Sarco DN150 CSF16 sterile air filter with EPM seals.

7.5 Stainless steel steam filters - spares

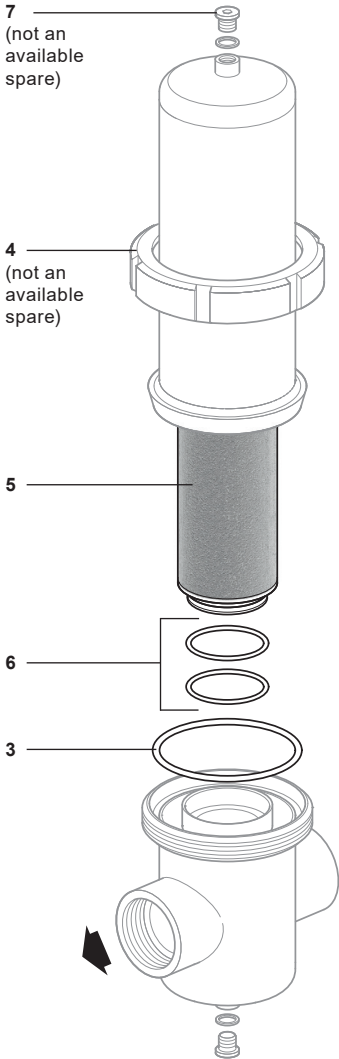

Fig. 11 DN8 to DN80

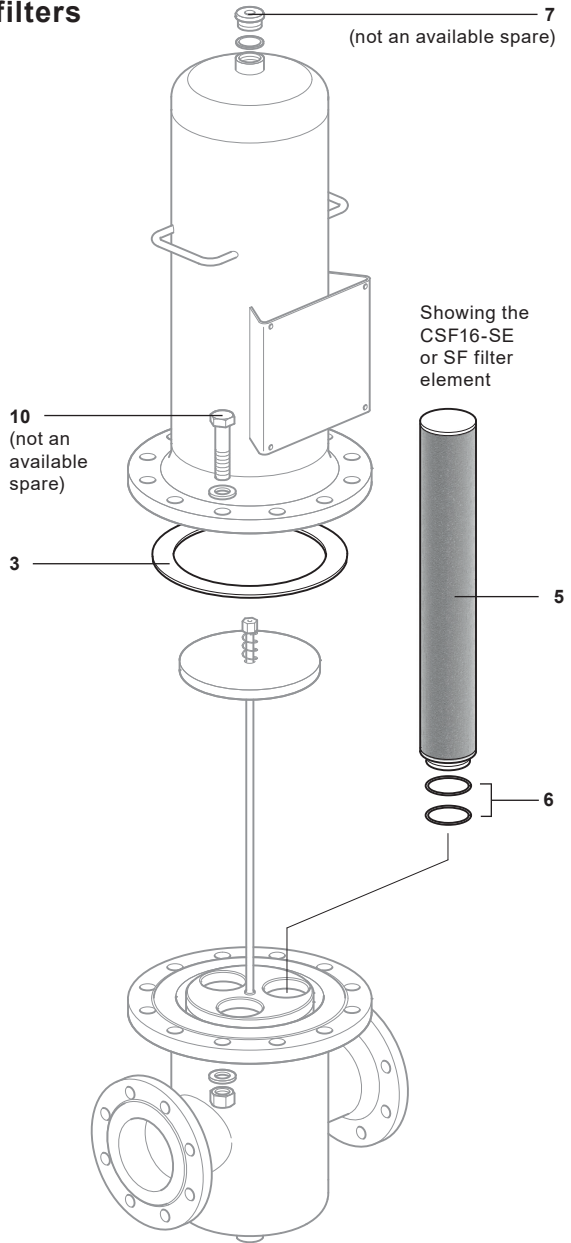

Fig. 12 DN100 and DN150L
(image shows DN100L)

7.6 Stainless steel sterile air filters - spares

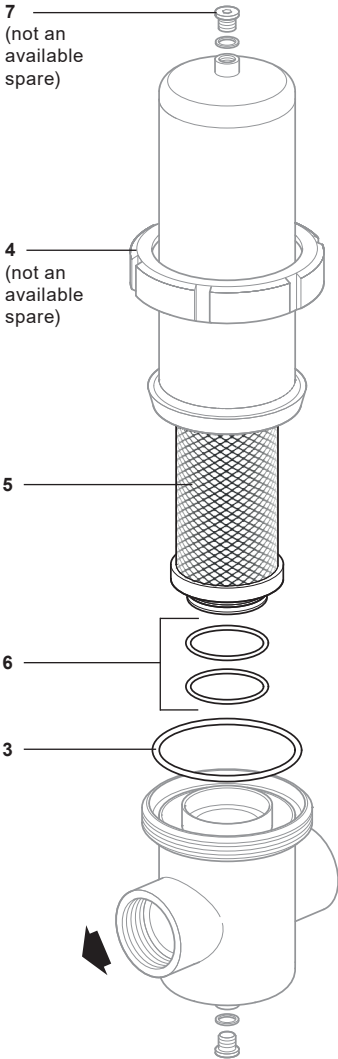

Fig. 13 DN80 to DN80

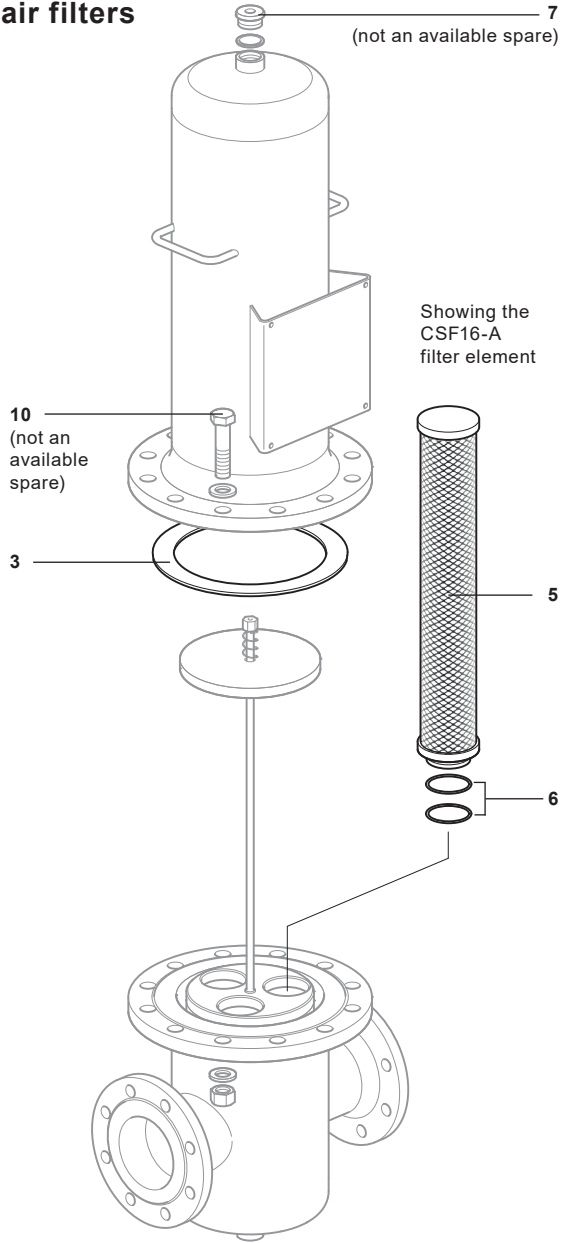

Fig. 14 DN100 and DN150L
(image shows DN100L)

